



Technische
Universität
Braunschweig

iBMB **MPA**
TU BRAUNSCHWEIG

PhD seminar on Fire Safety Science

Fire tests with bio-based insulation materials

Christian Northe M.Sc.

Technische Universität Braunschweig

Institute of Building Materials, Concrete Construction and Fire Safety (iBMB)

Division of Fire Safety

Content

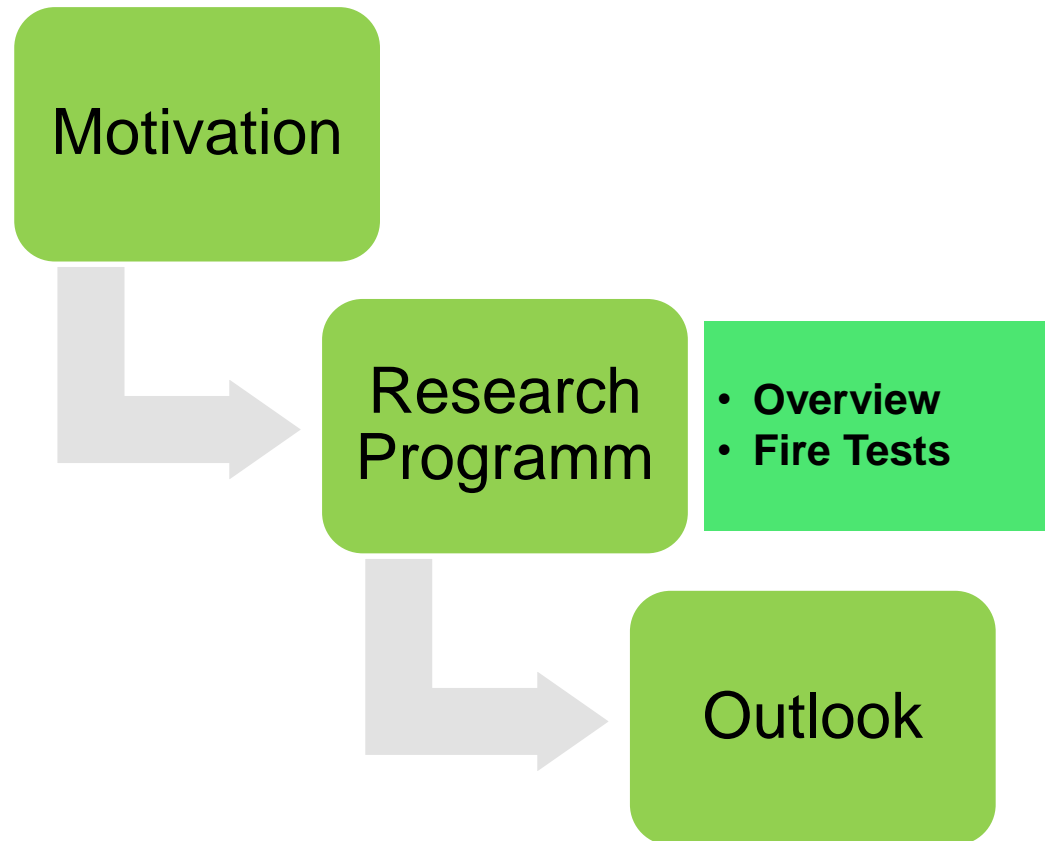

Motivation



Durch die Photosynthese nehmen Bäume für die Bildung einer Tonne Holz rund 1,9 Tonnen CO₂ auf, geben den Sauerstoff ab und speichern 500 Kilogramm Kohlenstoff.

Grafik: HOLZABSATZFONDS 2006

Research Program - Overview

□ Content and Aims

- **More than just insulation - additional benefits of insulating materials from renewable raw materials**
- 01.12.2016 – 30.11.2019/ (31.05.2020)
- Significantly increasing applicability of insulating materials from renewable raw materials
- Determination of required material characteristic values



Bundesministerium
für Ernährung
und Landwirtschaft



**Dämmstoffe aus
nachwachsenden
Rohstoffen**



Technische
Universität
Braunschweig

Research Program - Overview

□ Working Area Fire Safety

- Determination of material characteristic values in case of fire
- How to work with/ handle smouldering?
- Bio-based ETICS for building class 4 and 5
- Creation of a sample guideline

iBMB MPA
TU BRAUNSCHWEIG

Institut für Baustoffe,
Massivbau und Brandschutz | Materialprüfanstalt
für das Bauwesen

h²
Hochschule
Magdeburg • Stendal

Fraunhofer WKI

 **TECHNISCHE
UNIVERSITÄT
DRESDEN**

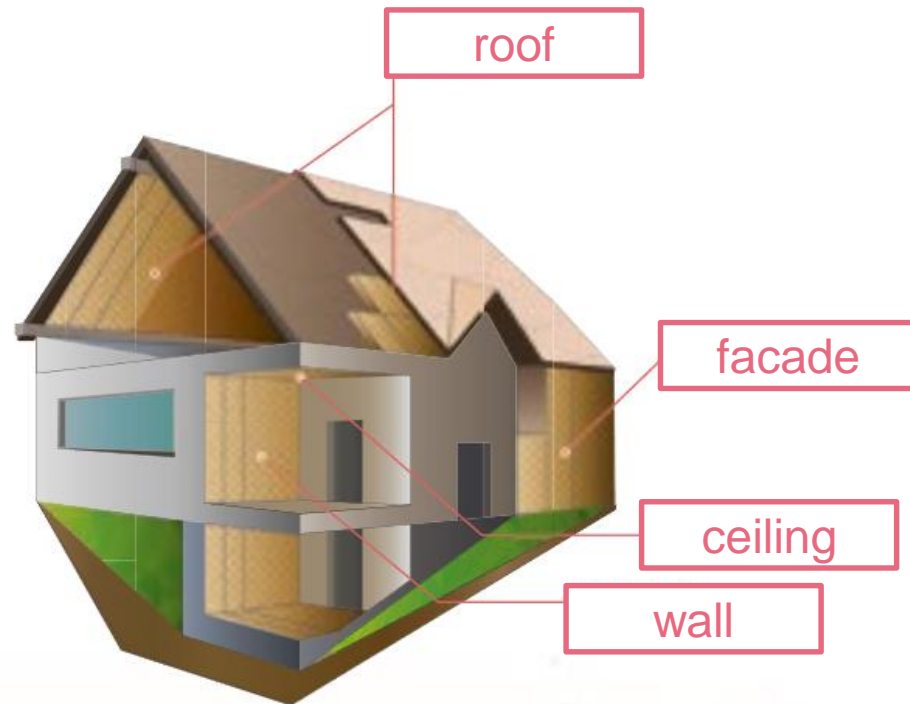

Technische
Universität
Braunschweig

Research Program - Overview

▣ Bio-based insulation materials

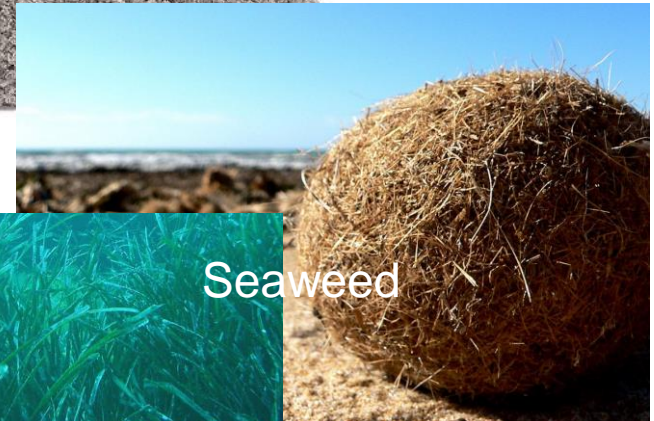
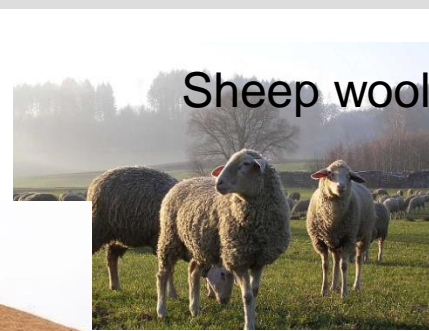

Research Program - Overview

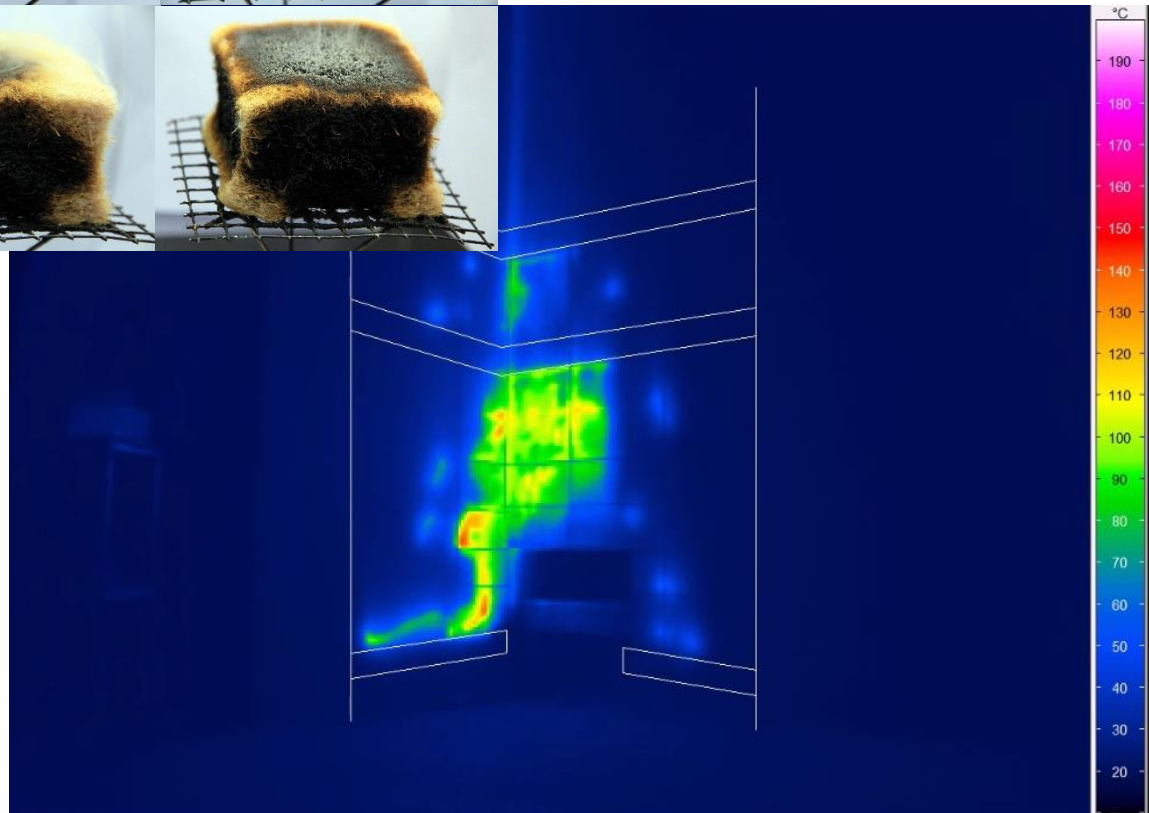

Research Program - Overview

- Material characteristic
 - TPS (conductivity, heat capacity)
 - Bomb Calorimeter (HOC)
 - Element analysis
- Fire tests according to
 - DIN 4102-15/16 Brandschacht
 - DIN EN 16733 Schwelprüfstand
 - ISO 5660 Cone Calorimeter (+ FTIR)
 - DIN 4102-8 Kleinprüfstand (+ FTIR)
 - EN 13823 SBI Test
 - DIN 4102-20 Fassadenprüfung
 - E DIN 4102-24 Sockelbrandszenario
 - ...

Content

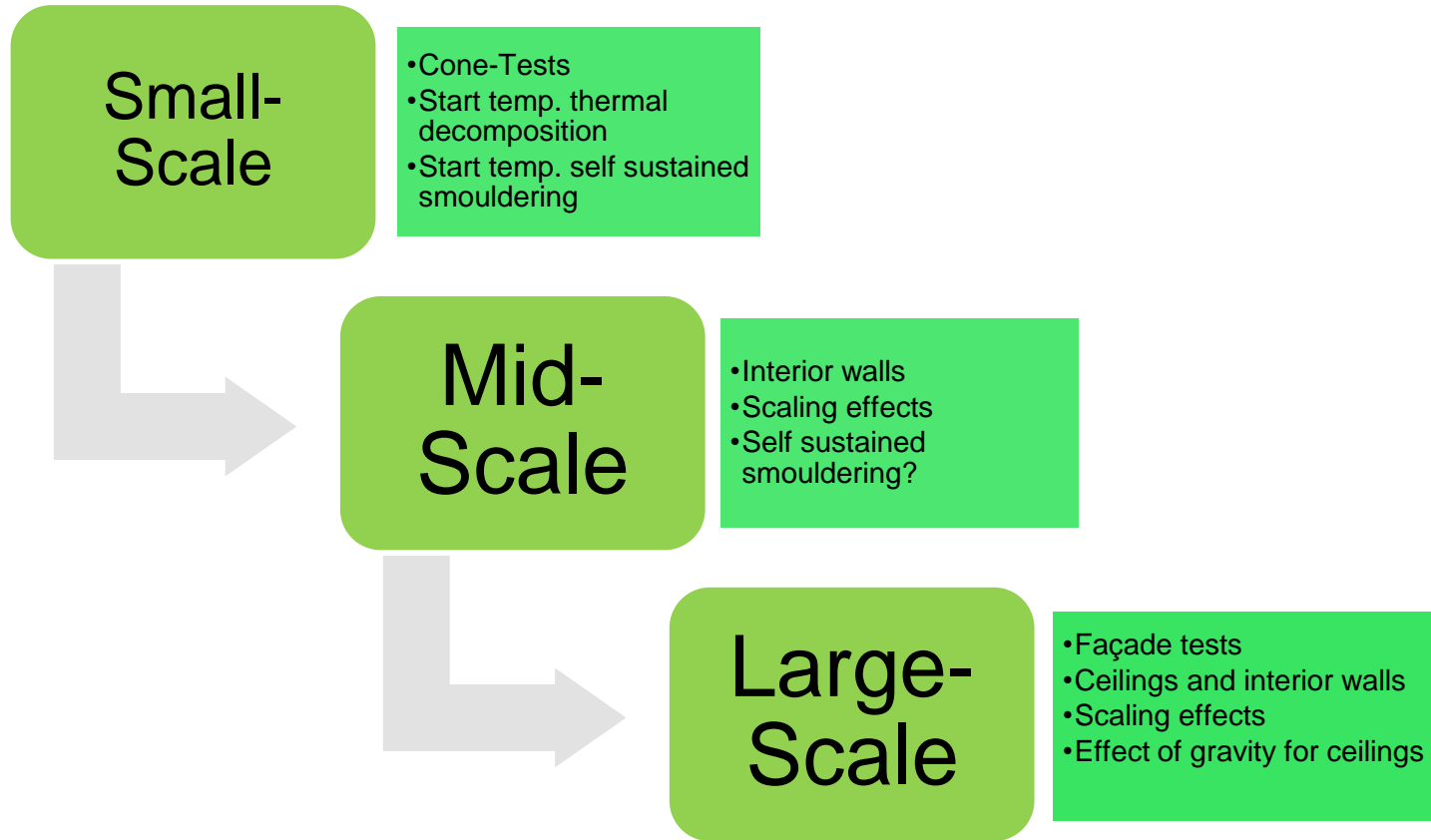

Content

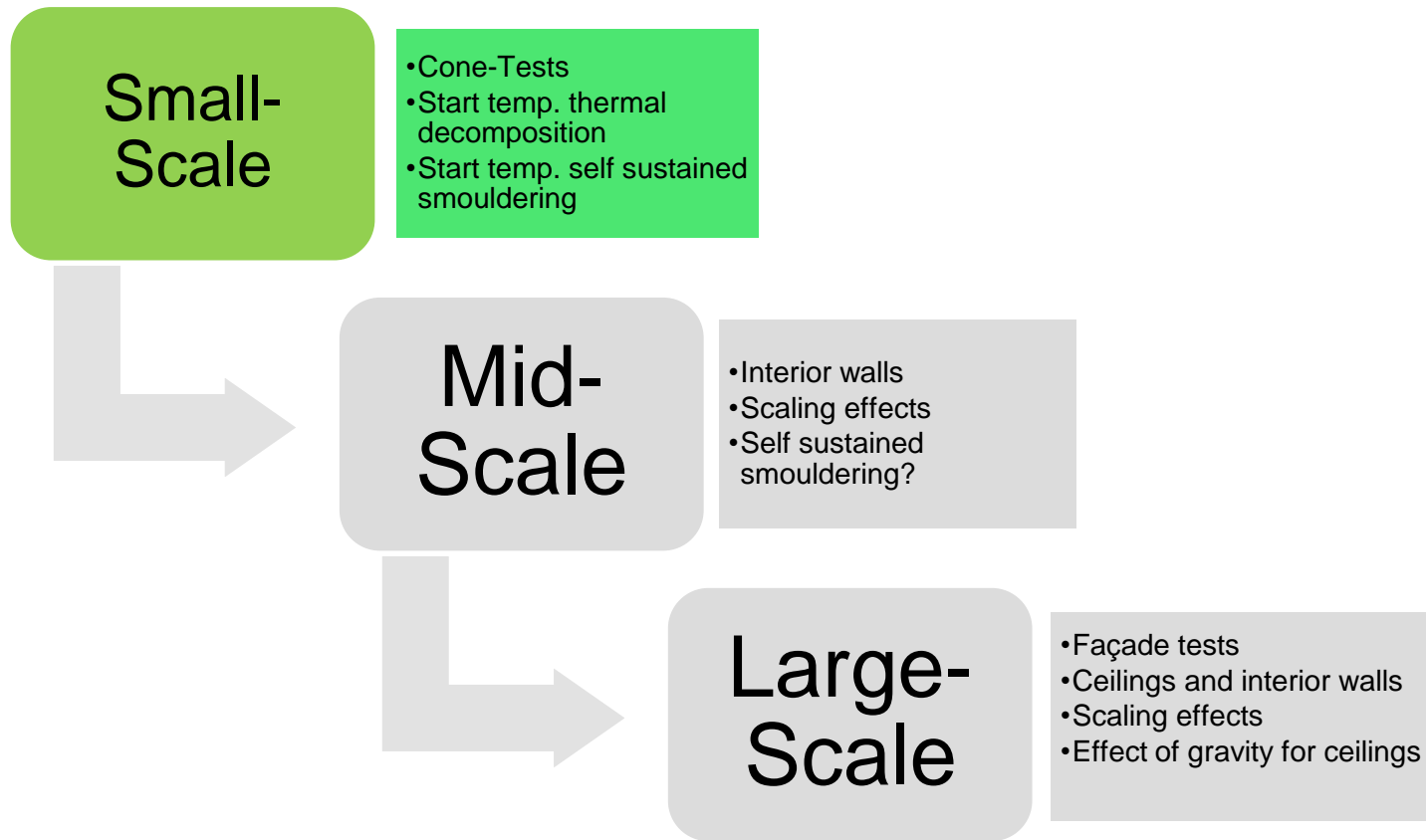

Small Scale – Research Program DIN EN 16733

- Strategies for the problem of smoldering
 - **Strategy (1)**
 - Prevent smouldering by fire retardants
 - **Strategy (2)**
 - Prevention of smoldering by a (thick) plaster system
 - **Strategy (3)**
 - stop smoldering fire by smoldering barriers

Small Scale – Research Program DIN EN 16733

- Smoldering test rig according to DIN EN 16733

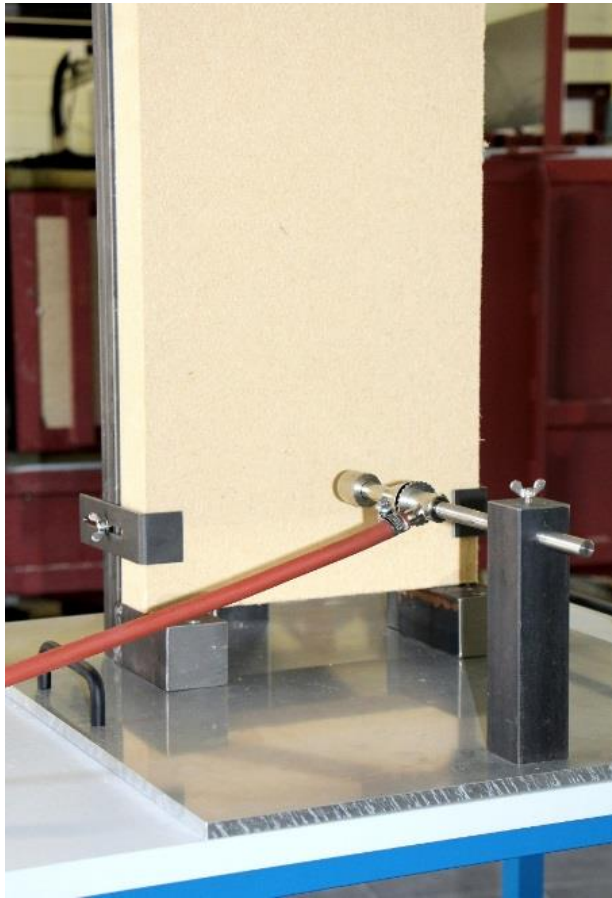

Small Scale – Research Program DIN EN 16733

- Smoldering test rig according to DIN EN 16733

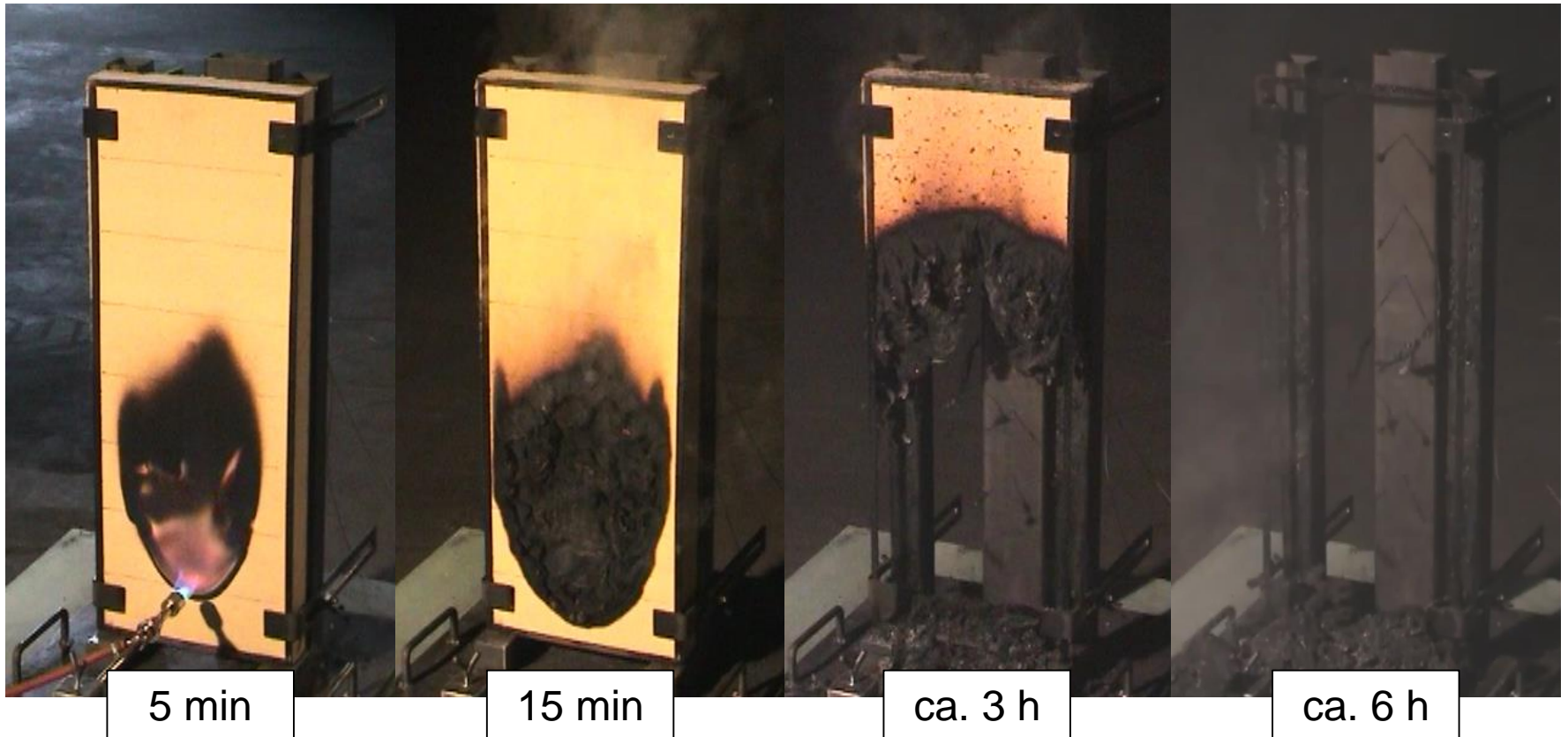

Small Scale – Research Program DIN EN 16733

- Summary of tests acc. to DIN EN 16733
 - Smouldering can not be prevented
 - Fire retardants (velocity 2 mm/min)
 - Reduction of air supply through a plaster layer (velocity about 0,3 mm/min)
 - **Strategy (1)** not realizable

 - Solutions to prevent the continuous glowing on the façade through a complete system
 - **Strategy (2)**
Prevention of smoldering by a (thick) plaster system
 - **Strategy (3)**
stop smoldering fire by smoldering barriers

Small Scale – Research Program DIN EN 16733

□ Summary of the approach to DIN EN 16733

- Smouldering fire is prevented
 - Fire retardants (velocity about 0,3 mm/min)
 - Reduction of smouldering through a plaster layer (velocity about 0,3 mm/min)
 - Strategy (1)
- Solutions to prevent the continuous glowing on the façade through a complete system
 - Strategy (2)
Prevention of smoldering by a (thick) plaster system
 - Strategy (3)
stop smoldering fire by smoldering barriers

Small Scale – Cone Tests

Temperature	Wood fibre	Hemp (F)	Hemp	Jute	Seaweed	Cellulose
Thermal decomposition	130	150	125	175	200	175
Self sustained smouldering	275	> 450	> 450	450	> 425	? 475

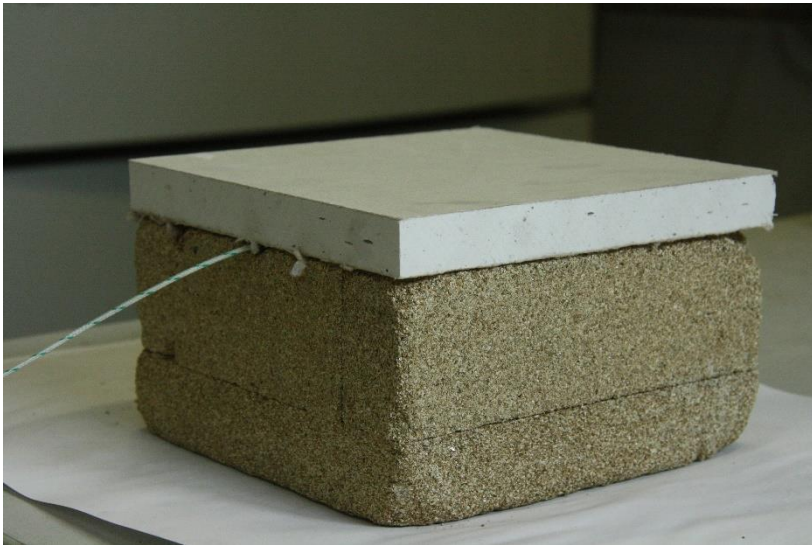

Small Scale – Cone Tests

Temperature	Wood fibre	Hemp (F)	Hemp	Jute	Seaweed	Cellulose
Thermal decomposition	130	150	125	175	200	175
Self sustained smouldering	275	> 450	> 450	450	> 425	? 475

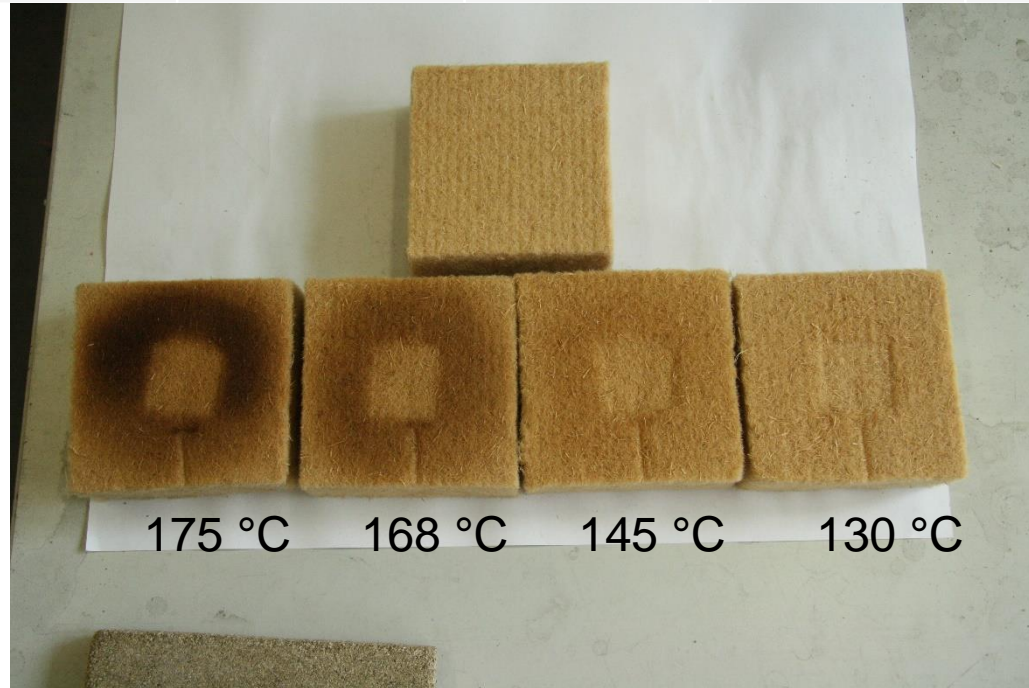

Small Scale – Cone Tests

Temperature	Wood fibre	Hemp (F)	Hemp	Jute	Seaweed	Cellulose
Thermal decomposition	130	150	125	175	200	175
Self sustained smouldering	275	> 450	> 450	450	> 425	? 475

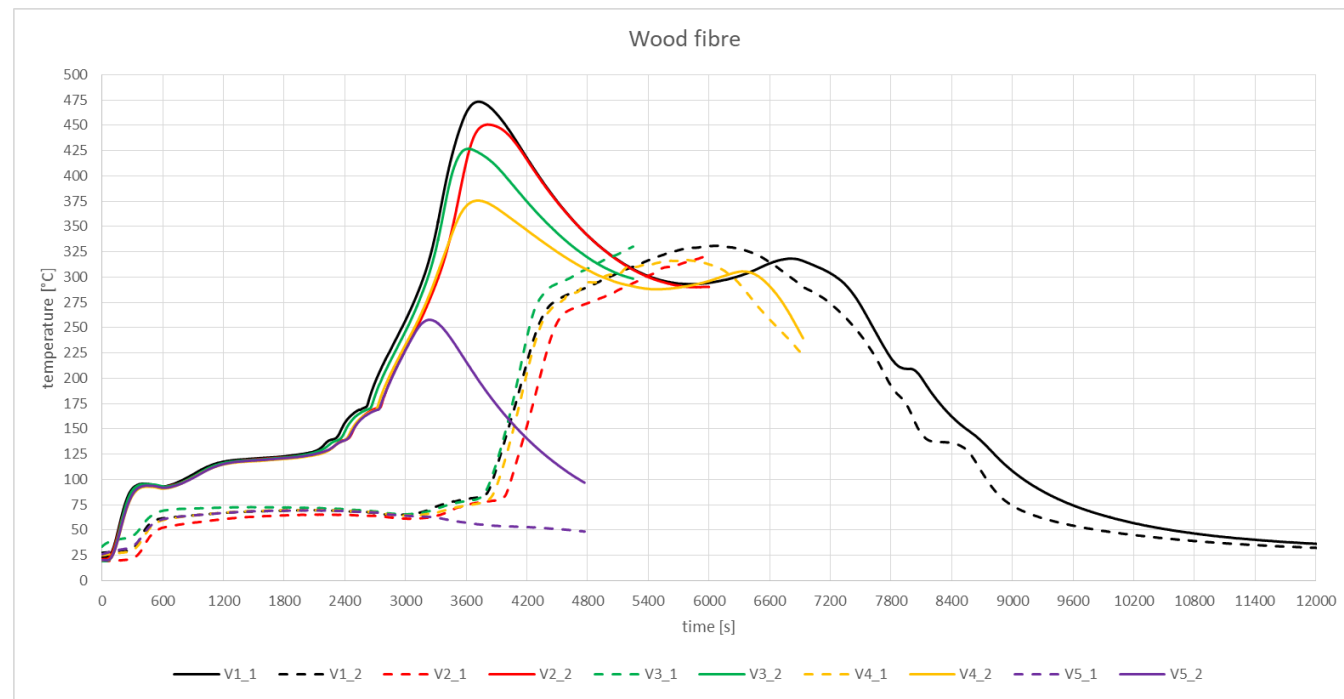

Content

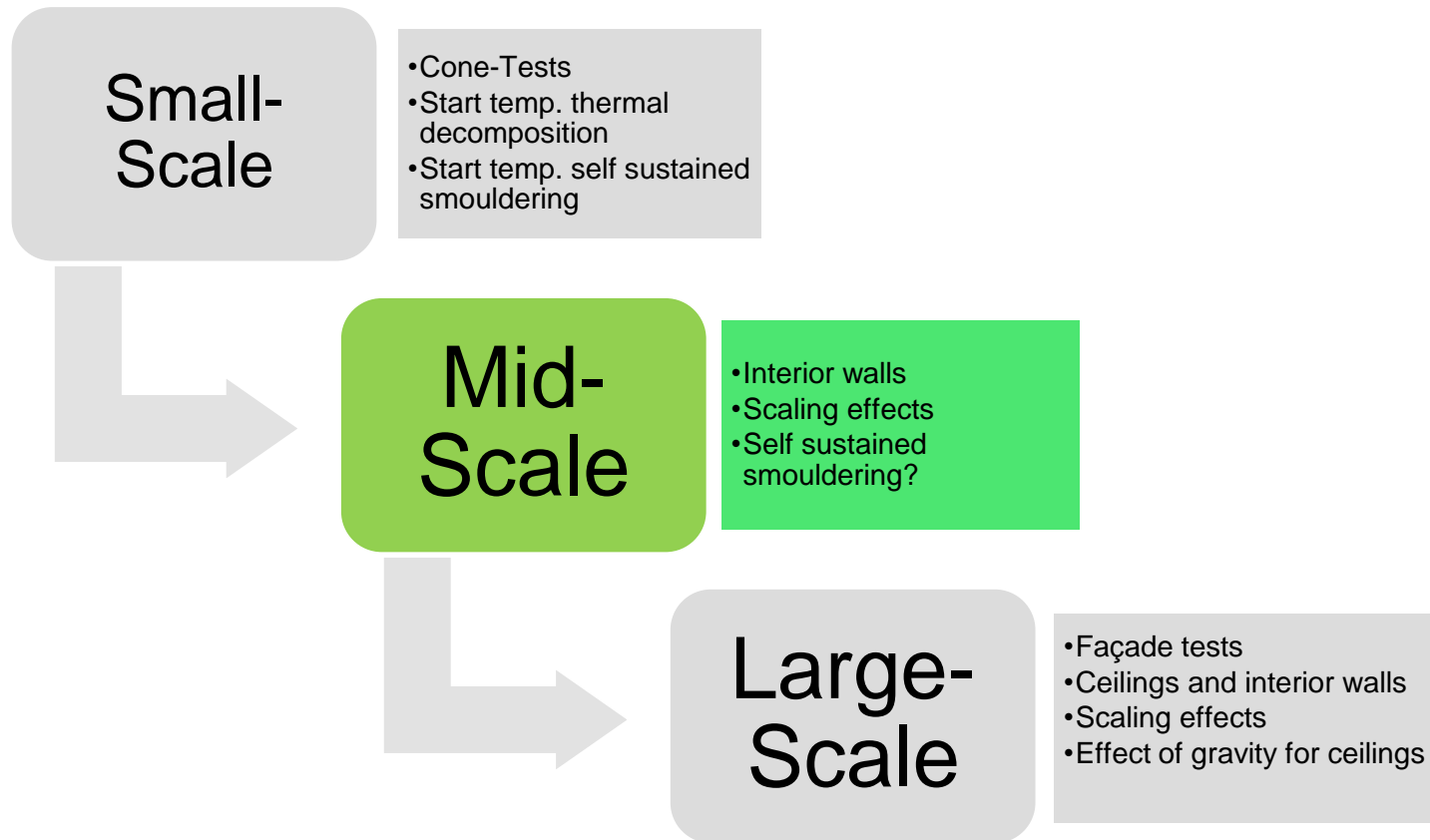

Mid Scale - Research Program DIN 4102-8

Fire tests according to DIN 4102-8

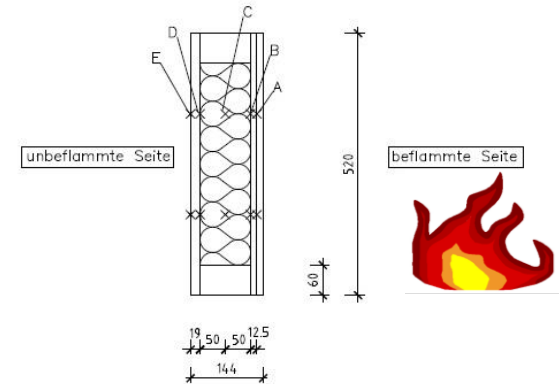

ISO 834 Fire Curve

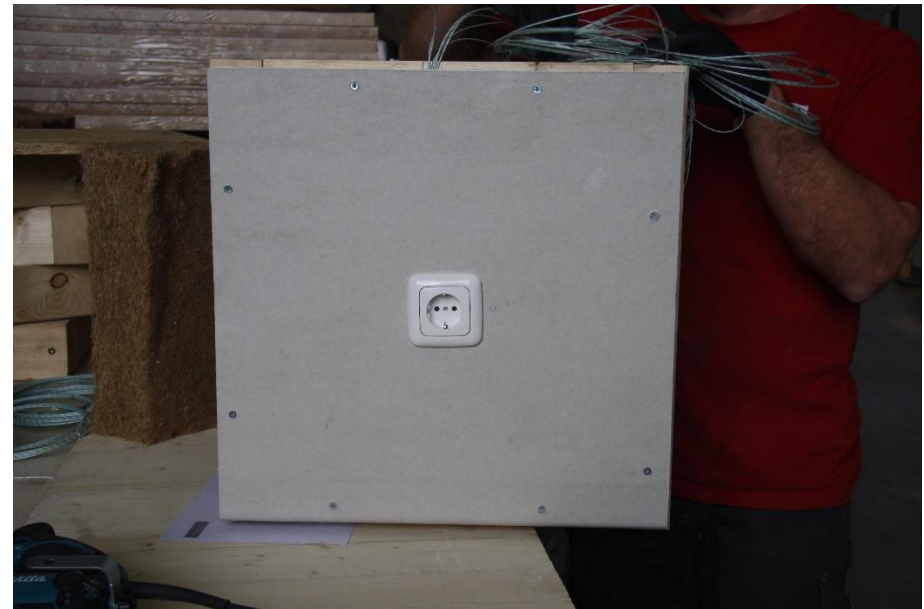

Mid Scale - Research Program DIN 4102-8

Construction details of specimen

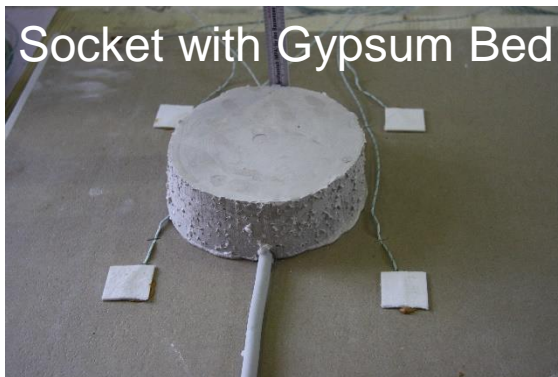
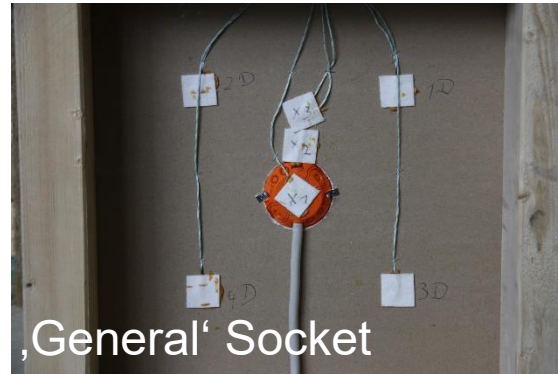

Mid Scale - Research Program DIN 4102-8

▣ Fire Test Hemp/ Jute 3, 1a



Mid Scale - Research Program DIN 4102-8

Cellulose K₂60

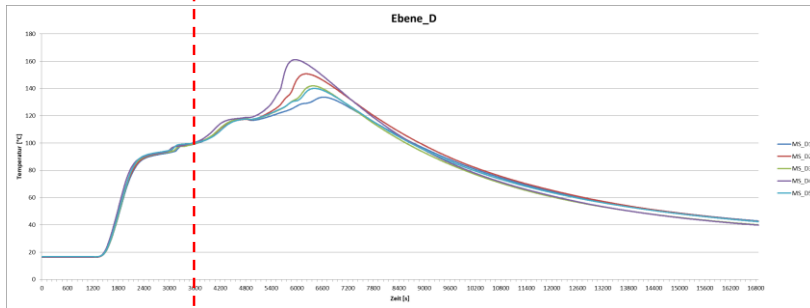
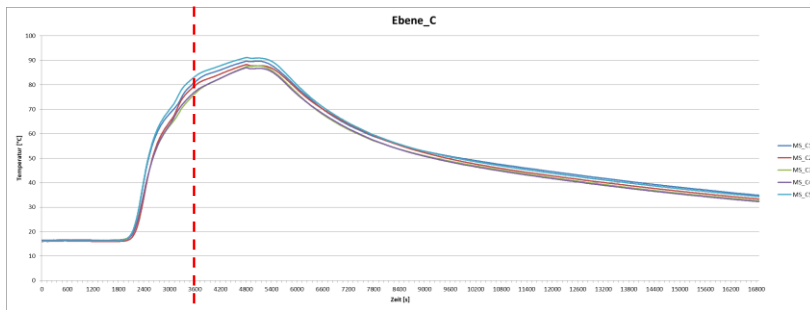
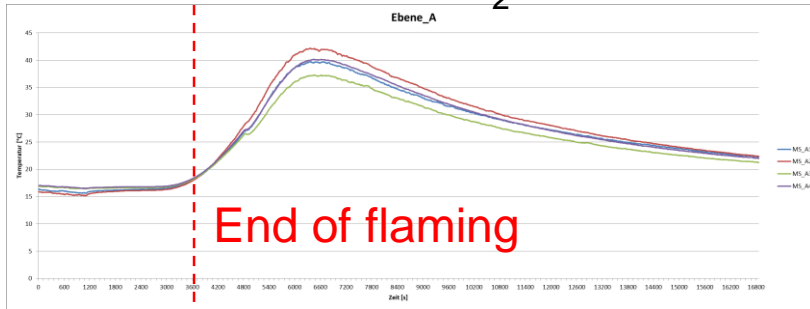

Cellulose K₂60 + HWD

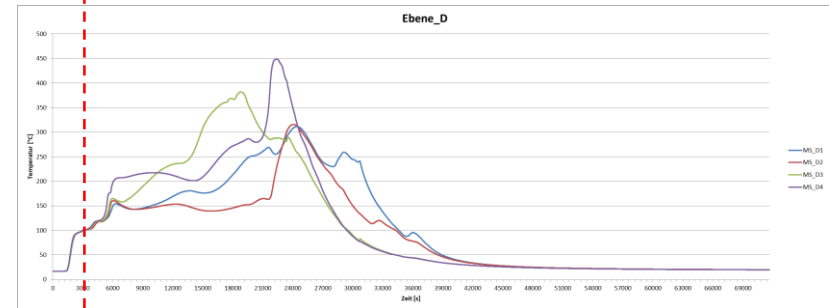
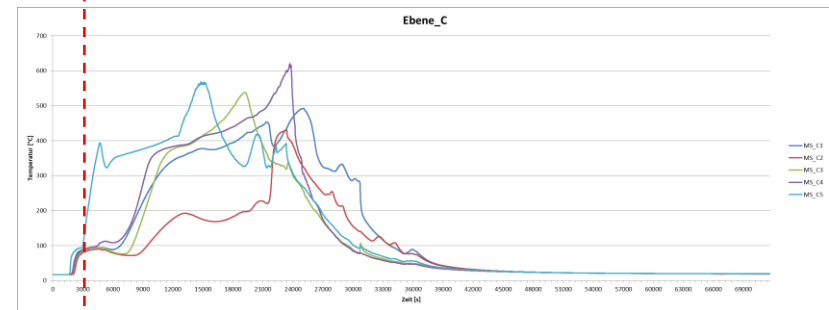
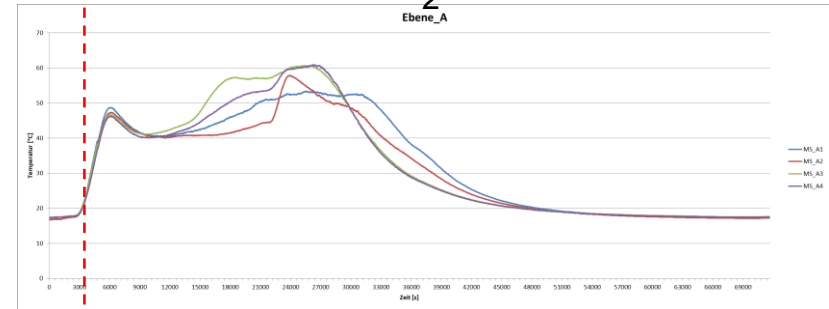

Mid Scale - Research Program DIN 4102-8

□ Investigation of walls/ ceilings

Ambient air
with CO_{amb}

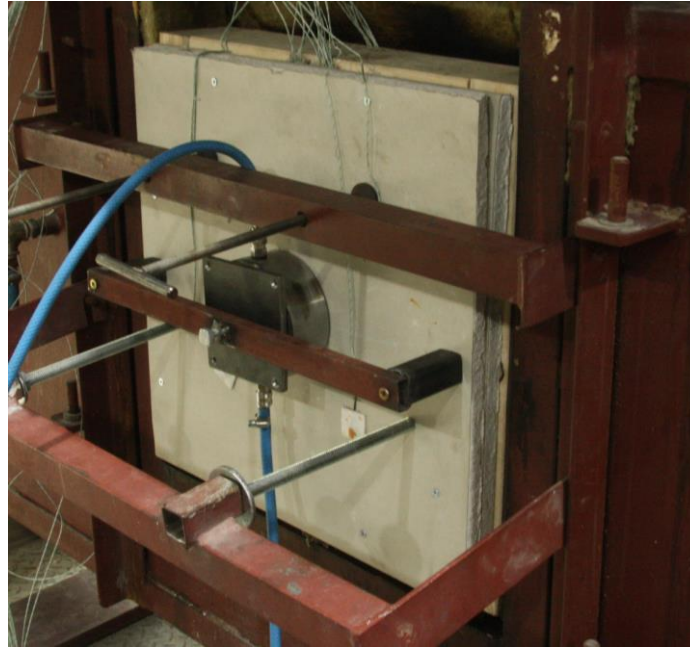

$CO_{amb} + CO_{Insulation}$ → FTIR

Mid Scale - Research Program DIN 4102-8

□ DIN 4102-8 + FTIR (Cellulose/ K₂60 + BSD)

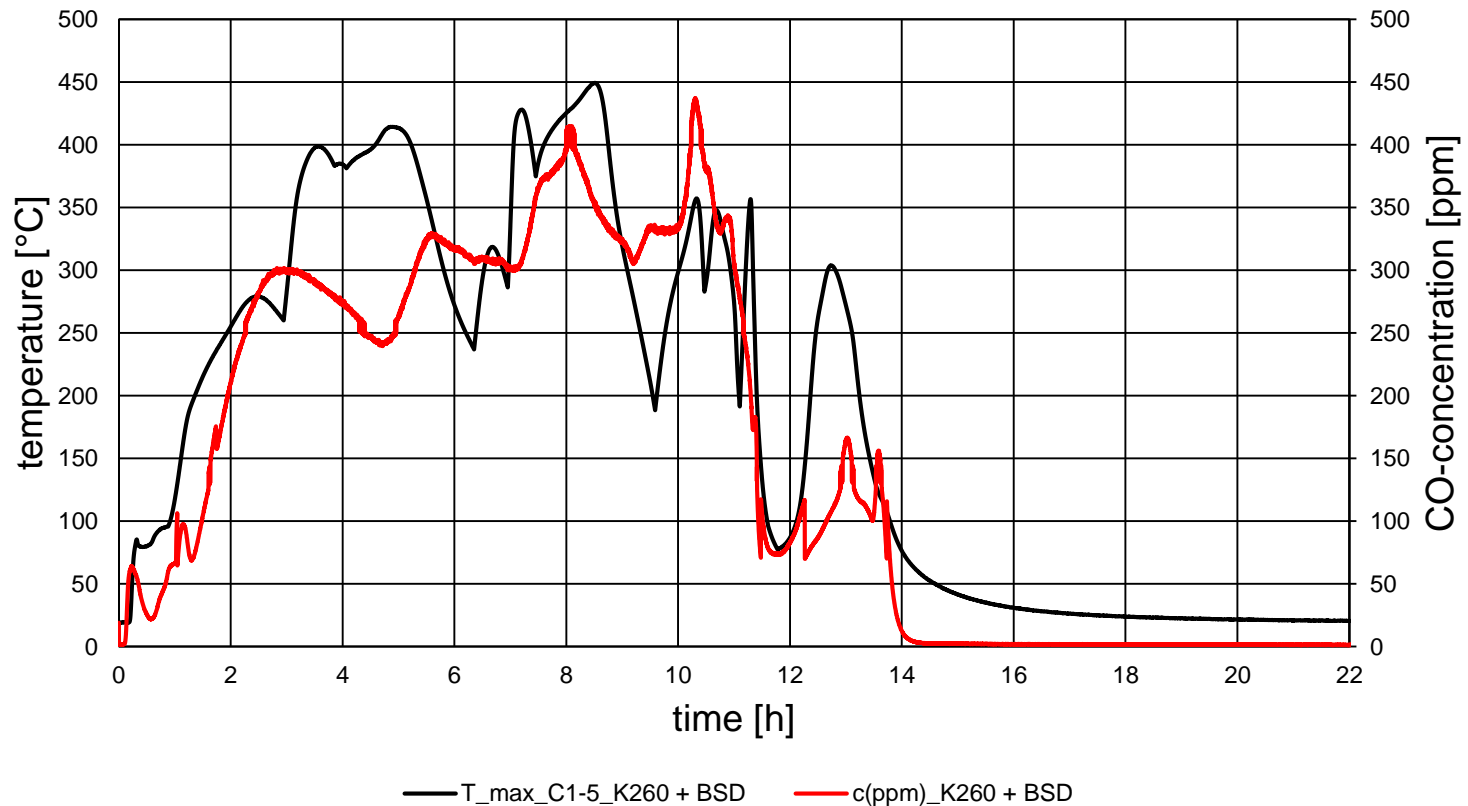

Mid Scale - Research Program DIN 4102-8

- Summary fire tests according to DIN 4102-8:
 - Temperature criterion ($T < 140 \text{ K}$) -> not exceeded
 - Smoldering depends on air conditions
 - Formation of combustible gases (outside of specimen! -> lighter test)
 - High smoke development
 - Production of CO (outside of specimen, measured with CO warning device & FTIR)
 - Ignition of combustible gases after opening of specimen
 - No uniform development of smoldering in depth & length

Mid Scale - Small Scale

Test	Construction	Layer	Fire Curve	T_30min	T_60min	T_90min
1,1	2-lagig GKF	2 x 18	ETK 94 min	129	414	650
1,2	2-lagig GF + Dämmung 100 mm	2 x 18	ETK 88 min	132	326	814
2,1	2-lagig GKF	2 x 18	ETK 60 min	121	412	
2,2	2-lagig GF	2 x 18	ETK 60 min	119	190	
3,1	2-lagig GF	2 x 18	ETK 95 min	114	291	532
3,2	3-lagig GKB	3 x 12.5	ETK 88 min	318	670	813
4,1	2-lagig GKF	15 + 18	ETK 90 min	185	479	681
4,2	2-lagig GF	15 + 18	ETK 90 min	143	366	746
5,1	2-lagig GF + Dämmung 100 mm	2 x 18	ETK 90 min	115	287	582
5,2	2-lagig GF + Dämmung 40 mm	2 x 18	ETK 90 min	121	289	650
6,1	2 lagig GF	2 x 15	ETK 70 min	203	429	
6,2	2-lagig GKF	2 x 15	ETK (75) min	206	499	
7,1	2-lagig GKF	2 x 18	Naturbrand_1	166	391	466
7,2	2-lagig GF	2 x 18	Naturbrand_1	221	554	425
8,1	2-lagig GKF	2 x 18	Naturbrand_2	86	116	196
8,2	2-lagig GF	2 x 18	Naturbrand_2	97	125	196
9,1	2-lagig GF	2 x 18	ETK 90 min	131	442	668
9,2	3-lagig GKB	3 x 12.5	ETK 90 min	282	636	774
10,1	2 lagig GF	2 x 15	ETK 90 min	177	519	815
10,2	2-lagig GKF	2 x 15	ETK 90 min	227	528	759
11,1	2-lagig GF	2 x 18	ETK 90 min	117	312	620
11,2	2-lagig GF	2 x 18	ETK 90 min	118	270	549
12,1	1-lagig GF	1 x 18	ETK 43 min	126		
12,2	2-lagig GKB	2 x 12.5	ETK (57) min	274		
13,1	1-lagig GF	1 x 18	ETK 60 min	124	463	
13,2	1-lagig GKF	1 x 18	ETK 60 min	115	516	311
14,1	2-lagig GKF	2 x 18	ETK 85 min	160	467	
14,2	2-lagig GF	2 x 18	ETK 85 min	163	441	745
15,1	1-lagig GKF	1 x 18	Naturbrand_1	291	643	628
15,2	2-lagig GKF	2 x 15	Naturbrand_1	98	313	494
16,1	1-lagig GKF	1 x 12.5	Naturbrand_1	661	808	21
16,2	1-lagig GKF	1 x 25	Naturbrand_1	110	465	556
17,1	1-lagig + Fuge GF	1 x 12.5	Naturbrand_1	681		
17,2	1-lagig + Fuge GKF	1 x 12.5	Naturbrand_1	620		
19,1	1-lagig + Fuge GKF	1 x 25	ETK (53) min	99		
19,2	1-lagig GKF	1 x 25	ETK (50) min	102		



Mid Scale - Small Scale

Test	Construction	Layer	Fire Curve	T_30min	T_60min	T_90min	Wood fibre 275 °C	Jute 450 °C
1,1	2-lagig GKF	2 x 18	ETK 94 min	129	414	650	O	X
1,2	2-lagig GF + Dämmung 100 mm	2 x 18	ETK 88 min	132	326	814	O	X
2,1	2-lagig GKF	2 x 18	ETK 60 min	121	412		O	X
2,2	2-lagig GF	2 x 18	ETK 60 min	119	190		X	X
3,1	2-lagig GF	2 x 18	ETK 95 min	114	291	532	o/x	X
3,2	3-lagig GKB	3 x 12.5	ETK 88 min	318	670	813	O	O
4,1	2-lagig GKF	15 + 18	ETK 90 min	185	479	681	O	O
4,2	2-lagig GF	15 + 18	ETK 90 min	143	366	746	O	X
5,1	2-lagig GF + Dämmung 100 mm	2 x 18	ETK 90 min	115	287	582	o/x	X
5,2	2-lagig GF + Dämmung 40 mm	2 x 18	ETK 90 min	121	289	650	o/x	X
6,1	2 lagig GF	2 x 15	ETK 70 min	203	429		O	X
6,2	2-lagig GKF	2 x 15	ETK (75) min	206	499		O	O
7,1	2-lagig GKF	2 x 18	Naturbrand_1	166	391	466	X	X
7,2	2-lagig GF	2 x 18	Naturbrand_1	221	554	425	O	O
8,1	2-lagig GKF	2 x 18	Naturbrand_2	86	116	196	X	X
8,2	2-lagig GF	2 x 18	Naturbrand_2	97	125	196	X	X
9,1	2-lagig GF	2 x 18	ETK 90 min	131	442	668	O	o/x
9,2	2-lagig GKF	2 x 12.5	ETK 88 min	282	636	774	O	O
10,1				177	519	815	O	O
10,2				227	528	759	O	O
11,1				117	312	620	O	X
11,2				118	270	549	o/x	X
12,1				126			O	O
12,2				274			O	O
13,1				124	463		O	o/x
13,2				115	516	311	O	O
14,1				160	467		O	o/x
14,2				163	441	745	O	o/x
15,1				291	643	628	O	O
15,2				98	313	494	O	X
16,1				661	808	21	O	O
16,2				110	465	556	O	o/x
17,1				681			O	O
17,2				620			O	O
19,1	1-lagig + Fuge GKF	1 x 25	ETK (53) min	99			O	O
19,2	1-lagig GKF	1 x 25	ETK (50) min	102			O	O



Content

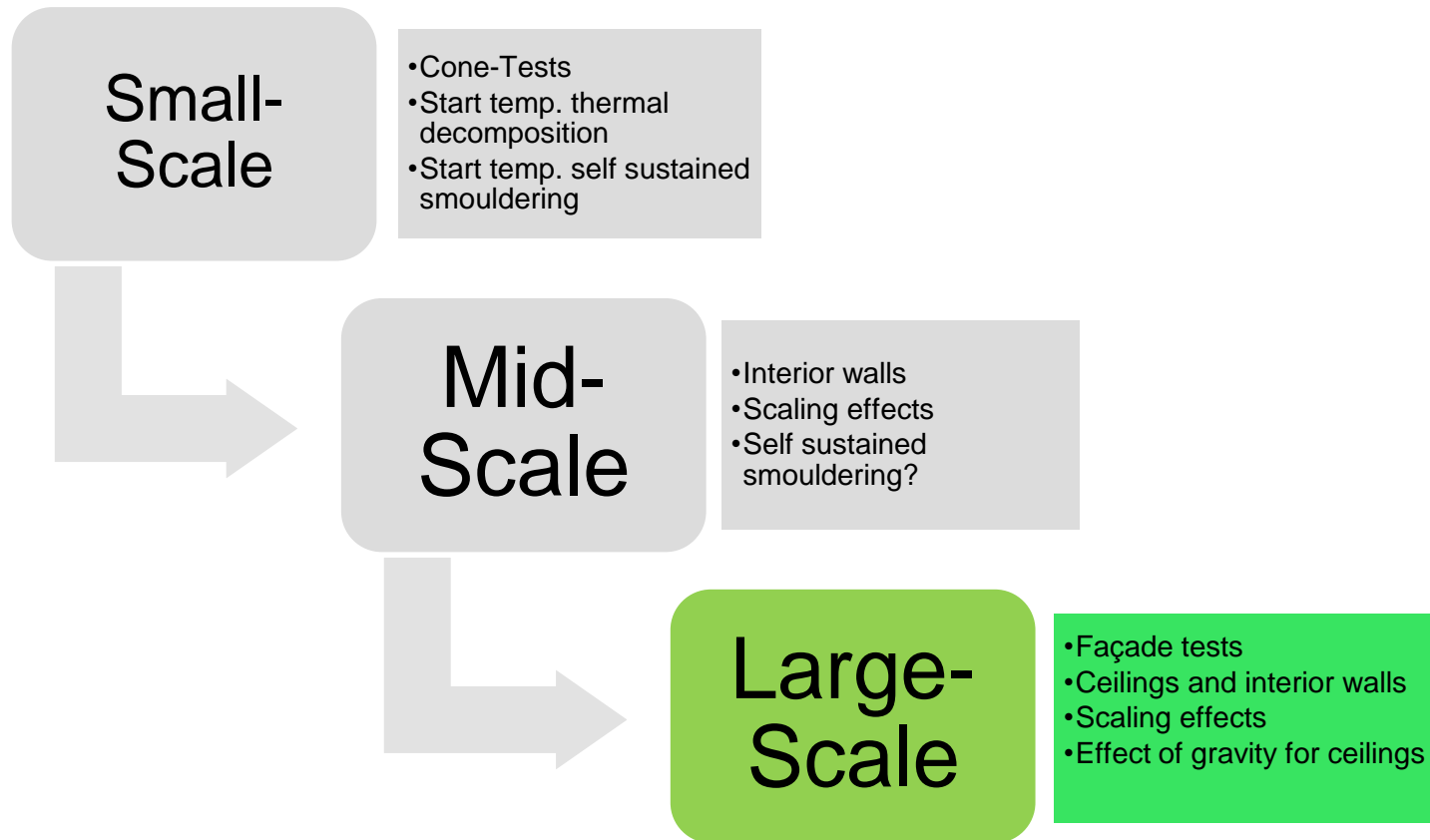

Large Scale - Research Program DIN 4102-20

- ❑ Strategies for the problem of smoldering (façades)
 - Strategy (1)
 - Prevent smouldering by fire retardants
 - Strategy (2)
 - Prevention of smoldering by a (thick) plaster system
 - Strategy (3)
 - stop smoldering fire by smoldering barriers

- ❑ Fire tests for interior walls
 - Different constructions and insulations
 - With/ without electrical installations

Large Scale - Research Program DIN 4102-20

□ Summary of glow tests

- Glowing can be prevented
 - Fire retardants (velocity about 0,3 mm/min)
 - Reduction of smoldering through a plaster layer (velocity about 0,3 mm/min)
 - Strategy (1)
- Solutions to prevent the continuous glowing on the façade through a complete system
 - Strategy (2)
Prevention of smoldering by a (thick) plaster system
 - Strategy (3)
stop smoldering fire by smoldering barriers

Large Scale - Research Program DIN 4102-20

□ Summary of glow tests

- Glowing can be prevented
 - Fire retardants (velocity about 0,3 mm/min)
 - Reduction of smoldering through a plaster layer (velocity about 0,3 mm/min)
 - Strategy (1)
- Solutions to prevent the continuous glowing on the façade through a complete system
 - Strategy (2)
Prevention of smoldering by a (thick) plaster system
 - Strategy (3)
stop smoldering fire by smoldering barriers



Large Scale - Research Program DIN 4102-20

□ Summary of glow tests

- Glowing can be prevented
 - Fire retardants (velocity about 0,3 mm/min)
 - Reduction of smoldering through a plaster layer (velocity about 0,3 mm/min)
 - Strategy (1)
- Solutions to prevent the continuous glowing on the façade through a complete system
 - Strategy (2)
Prevention of smoldering by a (thick) plaster system
 - Strategy (3)
stop smoldering fire by smoldering barriers



Large Scale - Research Program DIN 4102-20

- ❑ Fire Test acc. to DIN 4102-20
- ❑ Hemp façade, 200 mm
- ❑ Plaster layer 15 mm



Large Scale - Research Program DIN 4102-20

□ Results

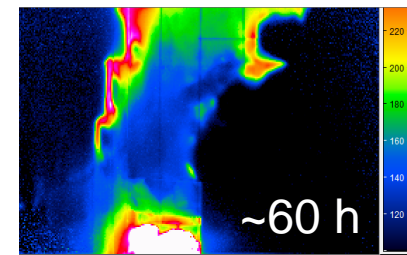
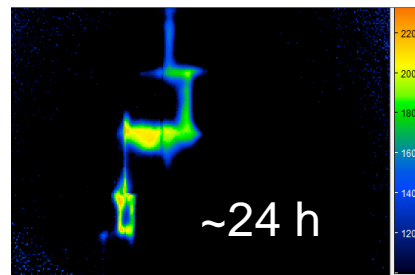
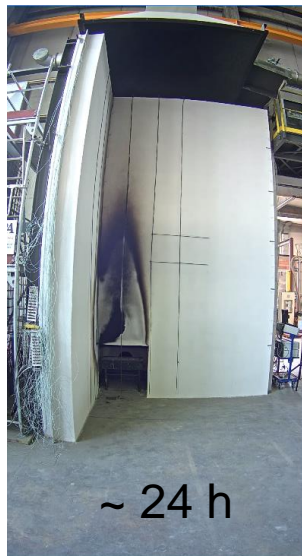
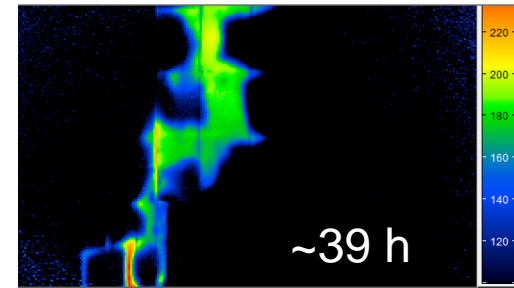
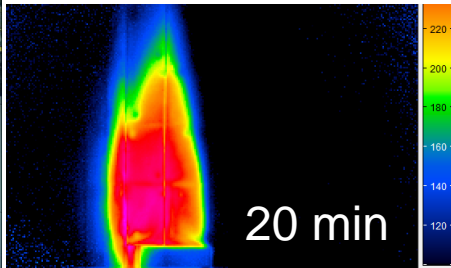
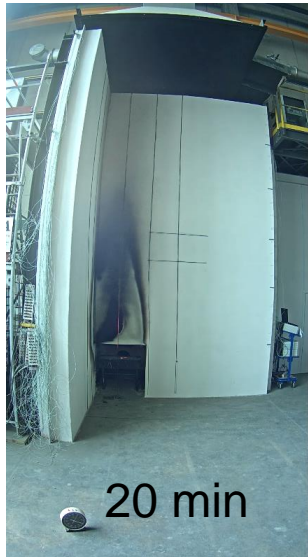

Large Scale - Research Program DIN 4102-20

Results

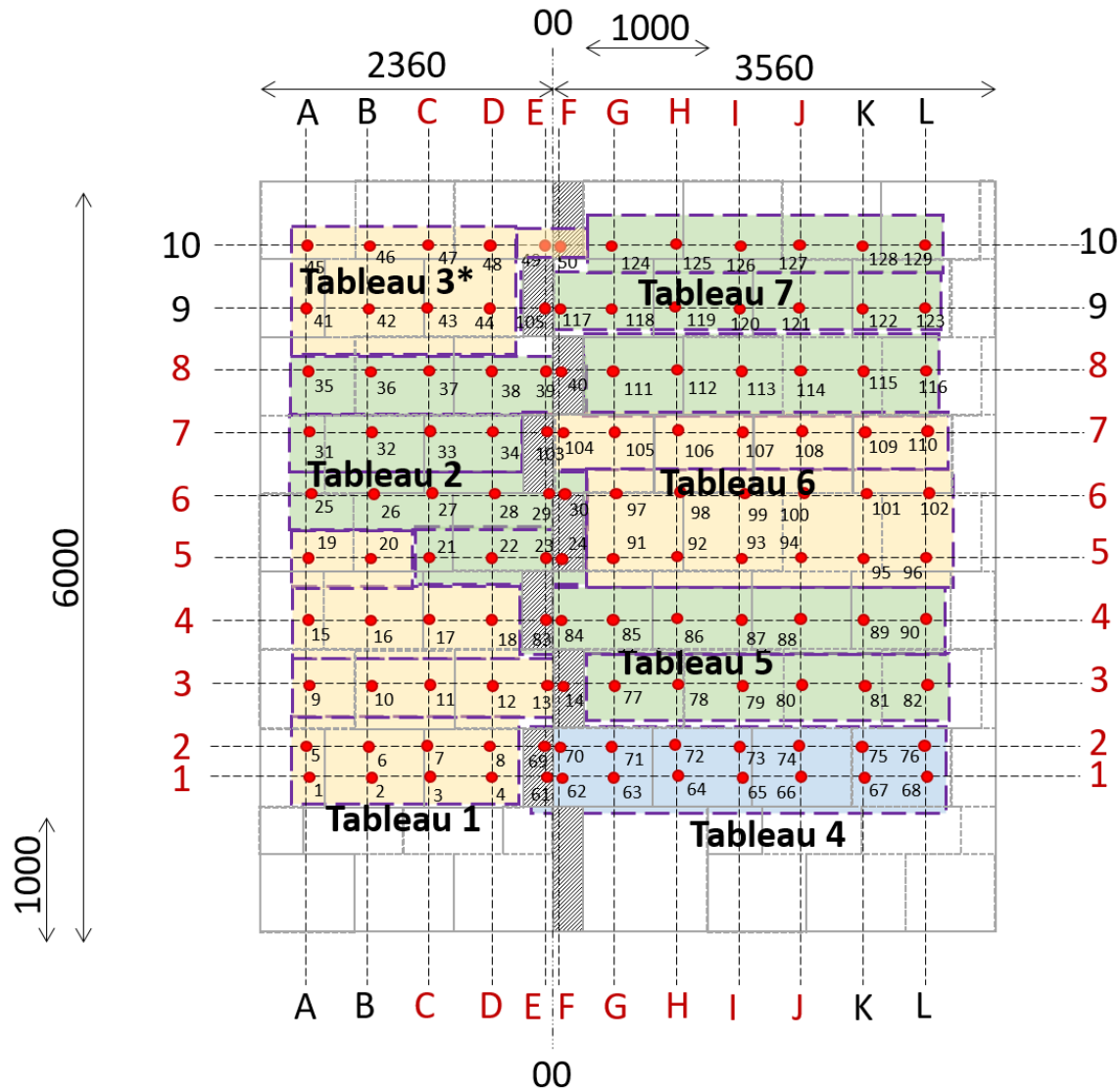

Large Scale - Research Program DIN 4102-20

□ Results

- Self sustained smouldering after 4 h from start
($T = 570 \text{ °C}$ after 20 min at MS G63 between plaster & insulation)
- Self sustained smouldering last longer than 15 h
(Axis F/ G/ H/ I $T = 490/ 310/ 230/ 65 \text{ °C}$,)
- Opening of façade in area of flaming after 59 h

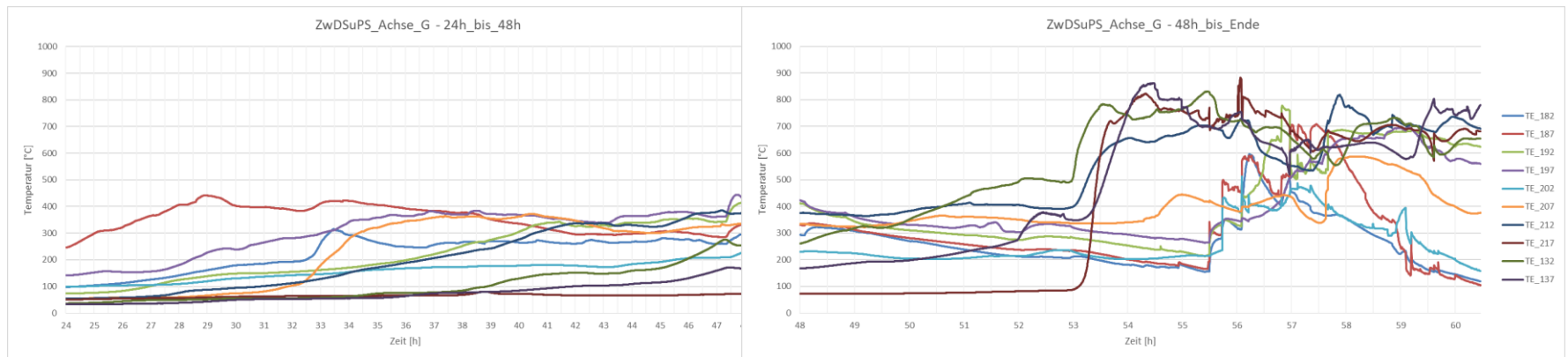

Hemp facade did not pass fire test

Outlook

- ❑ Further Large Scale Fire Tests
 - (Façade,) Walls, Ceilings -> different materials & constructions
- ❑ Extinguishing tests (hydrophobic/ non-hydrophobic materials)
- ❑ Further Small Scale Fire Tests

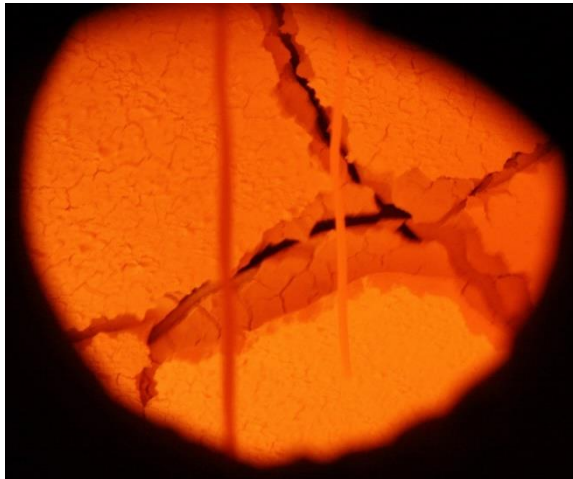

3x 12,5 mm GKB, Teil-8



Quelle: iBMB

Questions???



Contact and Funding

- Christian Northe
Technische Universität Braunschweig
Institut für Baustoffe, Massivbau und Brandschutz (iBMB)
Beethovenstraße 52
0531-391-5483
c.northe@ibmb.tu-bs.de



Dämmstoffe aus
nachwachsenden
Rohstoffen

- Funding
 - **More than just insulation - additional benefits of insulating materials from renewable raw material**
 - FKZ: 22011615



Bundesministerium
für Ernährung
und Landwirtschaft



Technische
Universität
Braunschweig